

The ILS22G Lectern - ILSWizard



ILS22G interactive lectern is a special product designed to use for presentations, in particular Powerpoint presentations using the Sho-Q presentation delivery program.

ILS22Setup

The program to configure your ILS22 with ease.

Introduction.

As the name of the program suggests, ILS22Setup gives the end-user the opportunity to program the behaviour of the ILS22 with respect to the control functions. The control functions are located to the left, bottom and right of the system LCD screen, and they are engraved on the glass plate.

Simply put, the ILS22 glass-plate buttons and headers can be used by the presenter, end-user or supporting technicians to execute commands directly (e.g. startup the Sho-Q Presenter package), enable or disable keyboard entries, increase or decrease system audio volume output etc. By pressing the Touch Screen Off button one can temporarily disable all these keys (until the On button is pressed). This is handy when presenters use the surface for other purposes than presenting.

The ILS22 and embedded functions in general can control:

- An attached projector. Power On, Power Off, or definable commands for example inquiring power status or lamp hours.
- Room light condition. Turn light higher or lower.
- Audio volume. Higher or lower or mute.
- Microphone volume, mute/un-mute.
- Display out selection, either Lectern itself or attached devices such as Notebook or auxiliary.
- Electrical pedestal elevation up/down.

All of these functions depend on the embedded system software driver which is called ILStranlator, and the setup as defined through ILS22Setup.

There are 3 possibilities per control function:

- The ILS22 will do it. Internal software in ILStranlator, internal relays and direct communication (RS232) to external devices are under direct control of the ILS22.
- The ILS22 has nothing to do with it. Glass-plate touches have no effect, external devices and circuitry is used.
- The ILS22 is setup as an intermediate or user-interface. Glass-plate touches will be translated into commands to external intelligent controllers which will perform the requested action.

ILS22Setup makes the lectern a hybrid system. You can choose and match according to local conditions and requirements:

- Select which device is taking the action.
- Define communication parameters.
- Which keys are programmed for action.
- Enter the ASCII command strings you want for external control.
- Which relays in the system are used.

The following schematics show how all components work together :

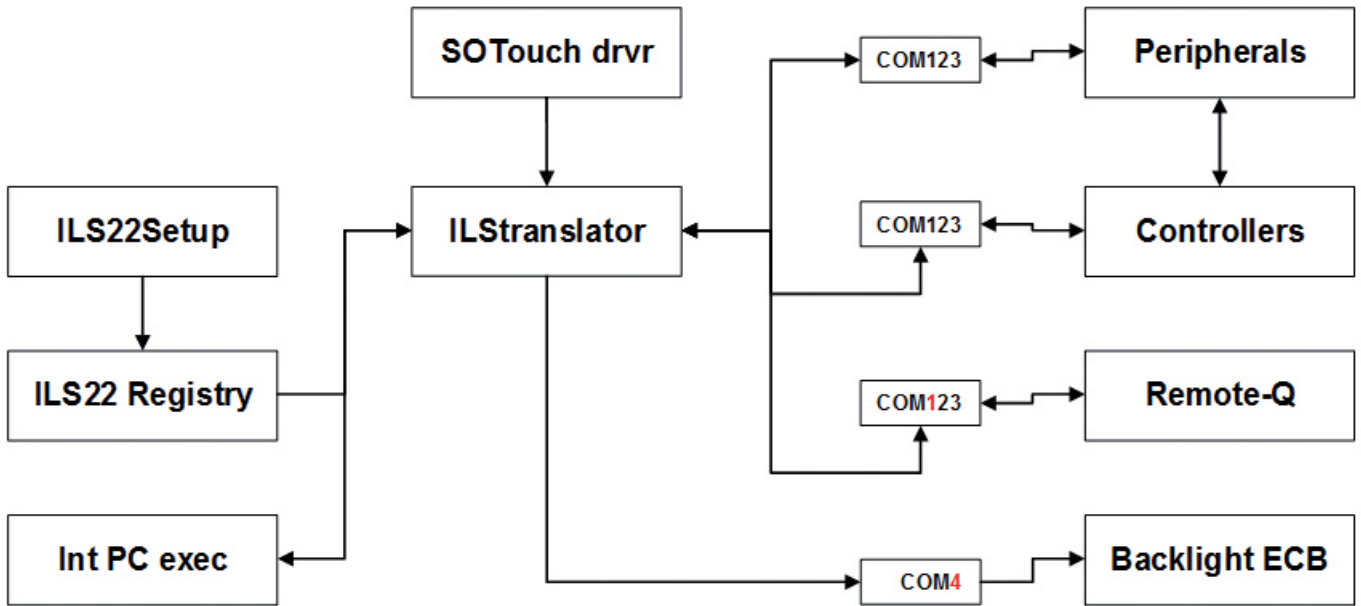

The ILS22Setup wizard is used to determine which peripherals are under direct control of the ILS22, which peripherals are controlled via external intelligent controllers, which communications settings and command strings are used to address peripherals and controllers, and whether remote control (for instance via Remote-Q or other controllers) is enabled. The ILS22Setup wizard is saving all this to the lectern system's registry.

At start up, ILStranlator will read the registry. If ILS22Setup was not used during installation, ILStranlator will use the default values. The SOTouch driver determines which glass plate buttons or header were pressed, and passes this on to ILStranlator. In turn, ILStranlator will 'translate' this to embedded system functions or pass it on to attached intelligent controllers, or react to external controller supplied commands.

The ILS22Setup Wizard will guide you through the possibilities. Each form will show what the default factory setting is.

The ILS22Setup Wizard.

The ILS22Setup program when first started, will show up as a XP-like Microsoft Wizard.

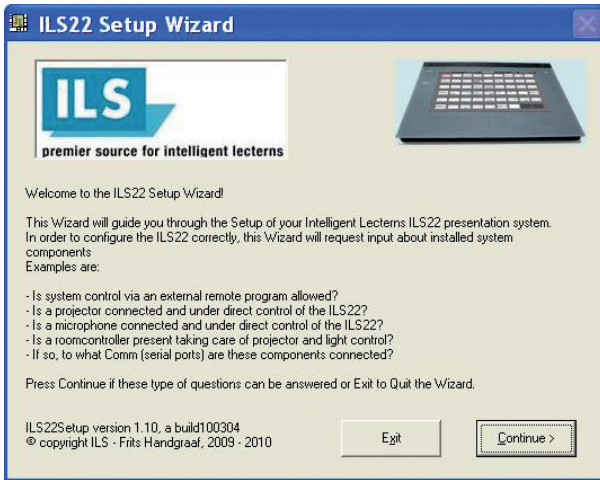

If ILS22Setup was executed before and parameters were saved to the system registry, the following form comes up:

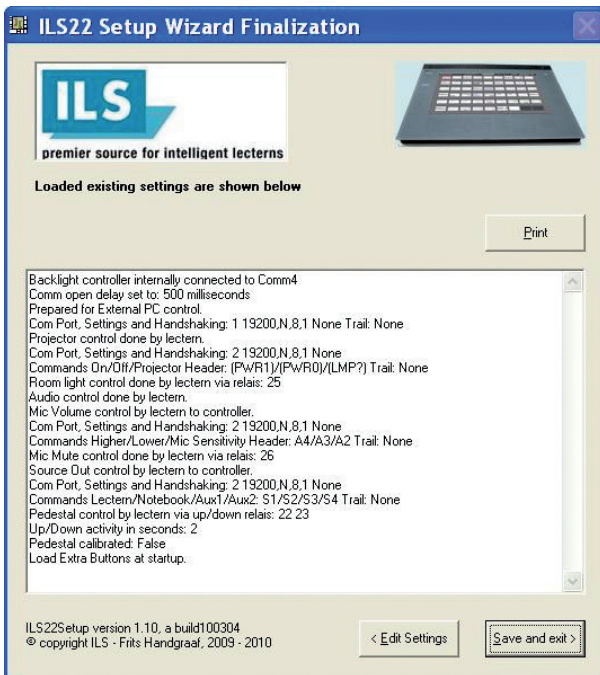

In order to change the Setup, press Edit Settings (Alt-E).

The wizard is self-explanatory, but we will continue with some examples.

Note: Moving the mouse pointer over a button, option, check box or text entry field will bring up related tool-tip-text.

Backlight controller



When the ILS22 is delivered in a standard setup, an internal PC is used to control the system and the backlight and relays controller. The internal PC has 4 serial comm ports, of which COM4 is used to communicate with the backlight controller (see above scheme). In situations where an external PC is used, ILStranlator needs to know to which serial port will be used to address the backlight controller inside the ILS22.

Note that only the serial port can be changed. The other communication parameters are fixed.

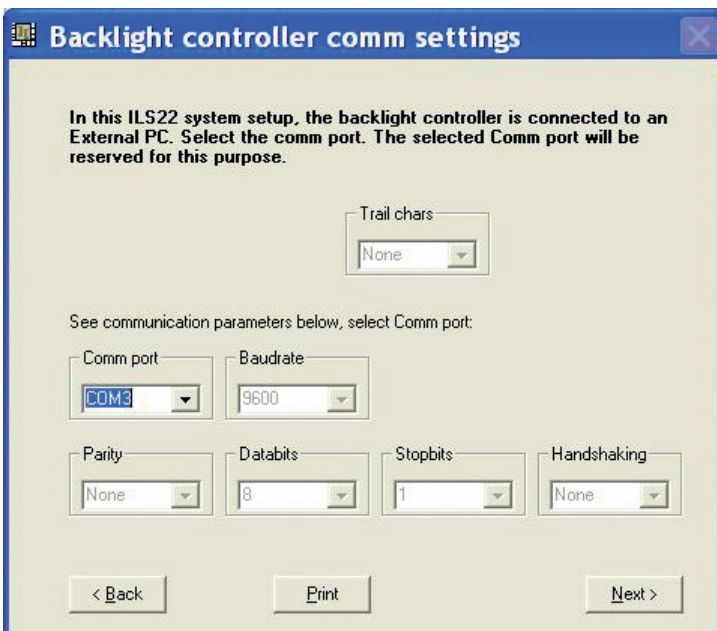

Comm Port open delay

Whether or not the backlight and relays controller is connected to the internal or to an external PC, the comm. ports needs some time after an open comm port command.



The screenshot shows a window titled "Comm Open delay" with a close button in the top right corner. The main text reads: "Whether the backlight controller is connected to the internal or an external PC, opening a comm port requires some delay. Increase the delay if the ports do not open, or decrease to startup ILStranlator faster." Below this text is a label "Comm open delay" above a text box containing the value "500". Underneath the text box, it says "Default: 1000 milliseconds". At the bottom left is a button labeled "< Back" and at the bottom right is a button labeled "Next >".

In the above form you can specify the number of milliseconds to wait before the comm. port gets active after opening it. If the internal PC is used, comm. ports may open successfully in just 250 milliseconds. With an external PC it may take longer. This entry allows to fine tune the system and has an impact on the ILStranlator start-up time.

Remote control.

If you want ILStranslator to also listen and allow control besides the direct glass plate buttons, keep that possibility open by selecting the second option.

Note: Select the second option if you also obtained Remote-Q.

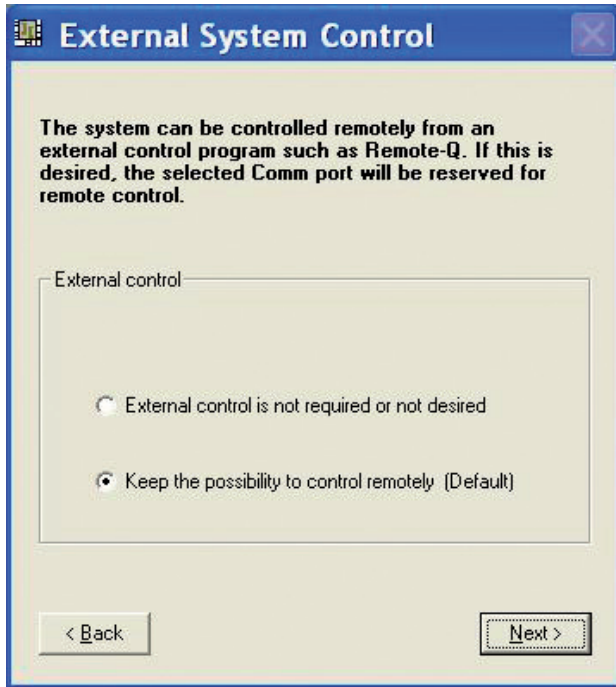

Select which Comm port on the ILS22 you want to use and the Baudrate to operate at.

The default value is 19200 baud, but here you can increase that depending on your remote control hardware capabilities.

Note: With a modern PC or laptop you should be able to successfully communicate at 115200 baud or higher.

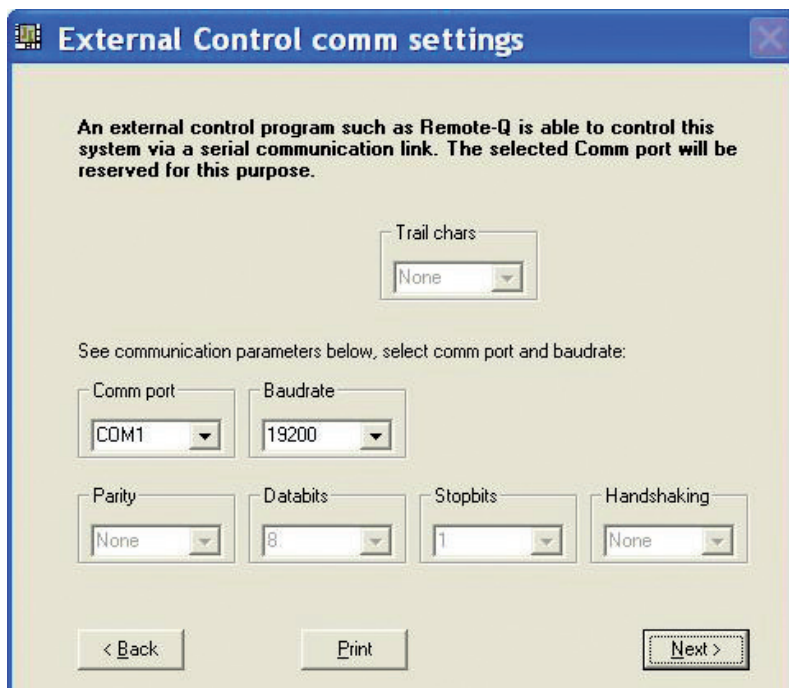

Projector control.

The projector control form allows selecting which device is controlling the projector concerning power on, power off or inquiry.

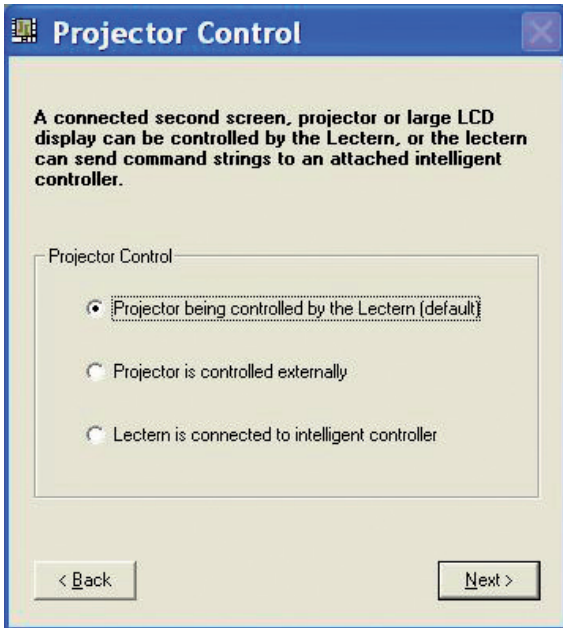

The screenshot shows a dialog box titled "Projector Control". It contains a text area with the following text: "A connected second screen, projector or large LCD display can be controlled by the Lectern, or the lectern can send command strings to an attached intelligent controller." Below this text are three radio button options: "Projector being controlled by the Lectern (default)", "Projector is controlled externally", and "Lectern is connected to intelligent controller". At the bottom of the dialog are two buttons: "< Back" and "Next >".

Select the first option if the projector is under direct control of the lectern.

Select the second option if the lectern has nothing to do with it, e.g. the projector functions are under direct control of a supplier supplied IR remote or a controller board room interface.

Select the third option if the lectern has to send out a command string to a connected intelligent controller.

Selecting option 1 or option 3 allows you to enter the communication parameters as shown in the following picture.

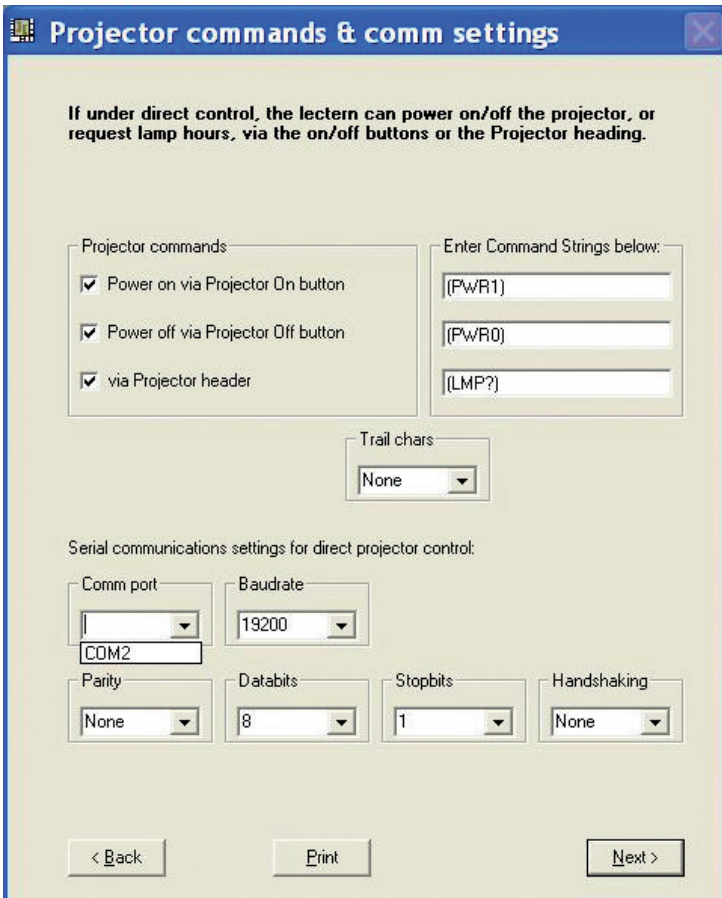

The screenshot shows a dialog box titled "Projector commands & comm settings". It contains a text area with the following text: "If under direct control, the lectern can power on/off the projector, or request lamp hours, via the on/off buttons or the Projector heading." Below this text are two main sections. The first section, "Projector commands", has three checked checkboxes: "Power on via Projector On button", "Power off via Projector Off button", and "via Projector header". The second section, "Enter Command Strings below:", has three text input fields containing "[PwR1]", "[PwR0]", and "[LMP?]", each with a small "x" icon to its right. Below these sections is a "Trail chars" dropdown menu set to "None". The bottom section, "Serial communications settings for direct projector control:", contains several dropdown menus: "Comm port" (set to "COM2"), "Baudrate" (set to "19200"), "Parity" (set to "None"), "Databits" (set to "8"), "Stopbits" (set to "1"), and "Handshaking" (set to "None"). At the bottom of the dialog are three buttons: "< Back", "Print", and "Next >".

Note that COM3 and COM1 were already reserved for Backlight controller communication and for remote control in this special configuration. If no remote control was desired (keep the option open), both COM1 and COM2 would be available.

In the standard ILS22Setup with internal PC, communication to the backlight controller is via the internal PC COM4 port, leaving COM1, COM2 and COM3 available for other connections.

The check boxes allow specifying whether the glass plate buttons are activated (check the box) or not activated (un-check the box).

In the Command string text boxes you can enter the ASCII strings to be send out to the projector to perform the function. In this example, the InFocus CLI command structure is used. (PWVR1) ,enter as text without quotes, will power up InFocus projectors, (PWVRO) will shut it down. A (LMP?) inquiry via the header will request lamp hours.

Some protocols require a trailing character to indicate the end of the command. Select under Trail chars (the InFocus projectors require none).

The bottom half allows to specify the communication setting. Select the Comm port to be used on the ILS22, baud rate, parity, number of data bits, number of stop bits and communication handshaking. People familiar with Windows embedded Hyperterminal should recognize the choices.

Instead of being under direct control, the ILS22 can be set up to control projectors via an attached controller capable of receiving command strings over a serial RS232 communication line.

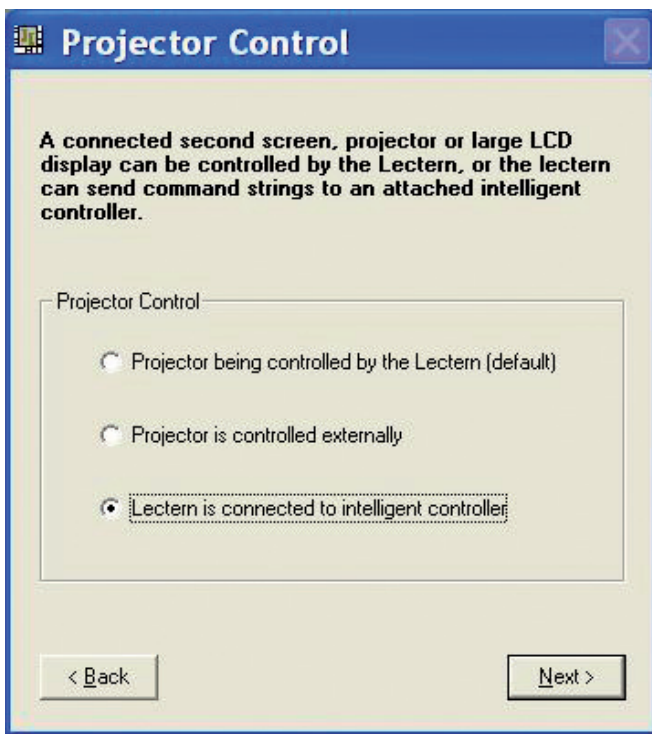

This form is representative for the remainder of this user guide:

- Either control is directly via the ILS22 Lectern (actually via ILStranlator)
- Control is performed via external circuitry (externally)
- Control is performed with ILStranlator functioning as a user interface to an attached intelligent controller

If attached to an intelligent controller, and ILTranslator is functioning as a user interface, you can specify which buttons are active, which commands to send and where to send them to.

The next item to configure is Projector control via an attached intelligent controller, this also applies to:

- Room light control (Lights)
- Mute Mic control (Mute Mic)
- Mic Volume control (Mic sensitivity)
- Master Volume control (PC Audio)
- Switch control (Source out)

If all of these functions you specify are to be done without interaction with ILTranslator, or ILTranslator as user interface, choose the second option which directs commands to be performed or controlled 'externally'. In that case, ILTranslator will not backlight these buttons.

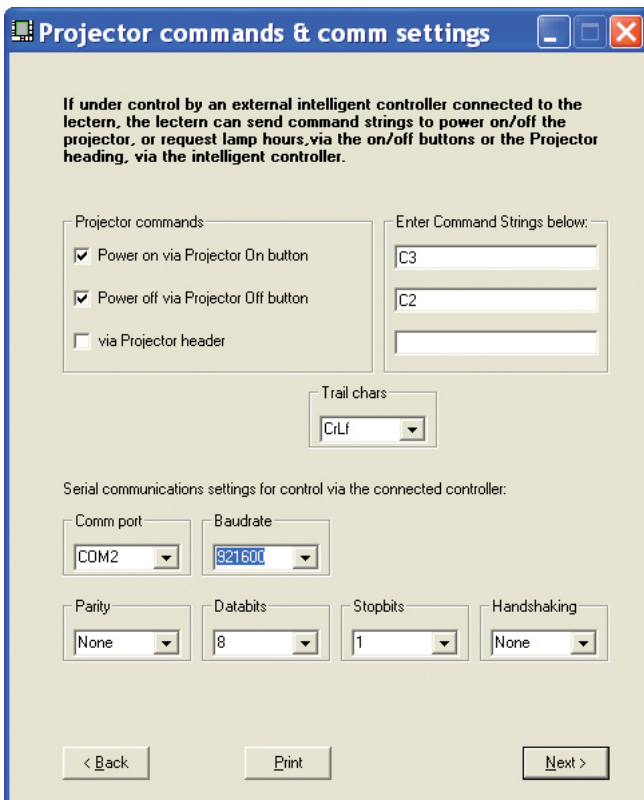

In the String command text boxes you can define which ASCII text string is sent to the attached controller. The controller will receive these commands and translate them into action for the projector connected to the controller.

In this example the intelligent controller will, after pressing the Power on button on the ILS22 glass-plate, receive the string 'C3', without the quotes as indication to power on the projector.

The controller will translate that into the correct command and perform the task of powering on.

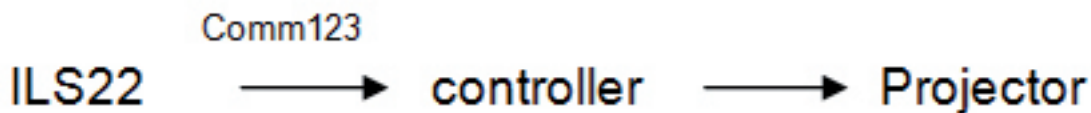

In this example the check box for the Projector header is unchecked, so no action will be taken after pressing the projector header on the ILS22 glass-plate.

Pedestal control.

If the ILS22 is mounted on an electrical pedestal (the ILS Powerlift), it can be elevated up or down .

Pedestal Controller

If the system is mounted on an electrical pedestal/foot, the up and down keys under Extra Buttons can be used to alter the height of the lectern up or down, via 2 of the internal relais in the system.

Pedestal elevation control

Pedestal up/down is controlled by the Lectern (Default)

Pedestal elevation is controlled externally

< Back Next >

Pedestal Relais

The elevation Up and Down keys under Extra Buttons are used to elevate the lectern. Please select below which relais is used to move the lectern up, and which relais is used to move the lectern down.

Relais number up: 22 (Default: 22)

Relais number down: 23 (Default: 23)

Select below how many seconds the relais should be closed for up/down elavation:

Nr of seconds: 1.5 (Default: 2.0)

< Back Next >

The ILS22 has build-in relays for control functions.

By default, relays 22 and relays 23 are reserved for driving the motor in the optional electrical pedestal from ILS (supplied with the ILS22G).

One can define the number of seconds the relays will be closed (number of seconds for up/down movement). Default is 2 seconds.

If under direct control of the lectern (ILStranlator), the following form will show up.

Via Powerlift Calibration you can specify ('Mark') the lowest setting, which in turn will be used to provide a calculated indication in ILStranlator (and Remote-Q) what the current height is calculated in cm's and inches.

This calculated indication is shown in ILStranlator/Extra Buttons.

Powerlift Calibration

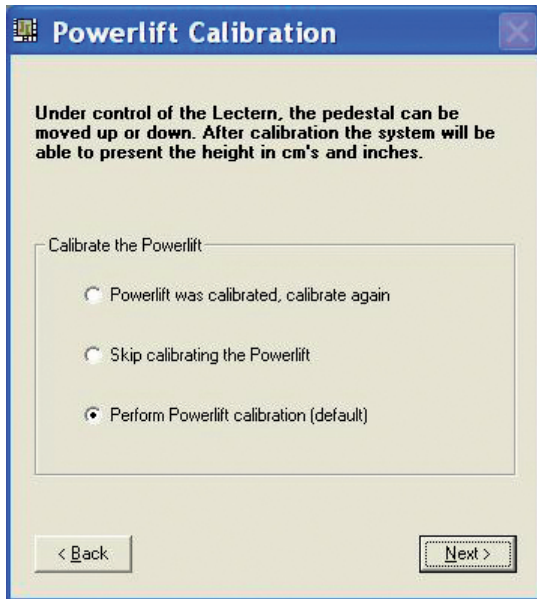

Select the first or third option to calibrate the Powerlift.

After verifying that the comm port to the backlight/relays controller is free for communication, the following form will show up (if not, a window will appear where you can to stop ILStranlator or an other program that is communicating over the comm port):

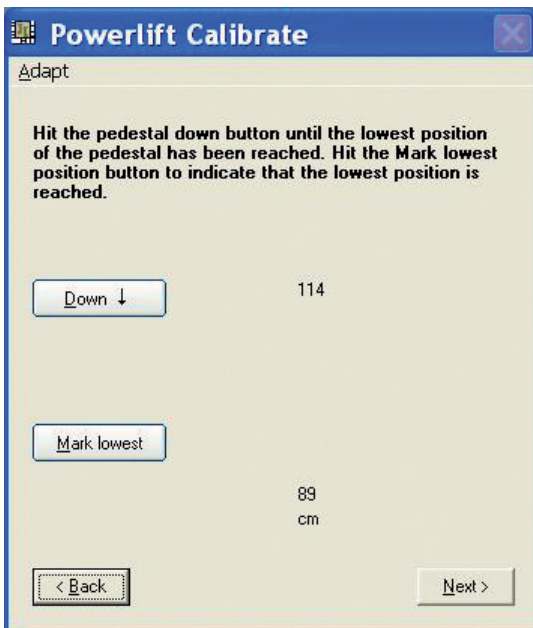

The form shows the approximate lowest and highest position measured in centimeters (in this case 89 cm as the lowest setting, and 114 cm as highest). The positions are measured at the front (Presenter side) from ground up to the top of the pedestal.

Note: There might be later Powerlift engines which go lower or higher, or have a different rise-time from lowest to highest measured in seconds (current Powerlift installations go from 89 cm at the lowest setting, to the highest setting at 114 cm in roughly 17.5 seconds). If in doubt, use Alt_A or the menu Adapt entry to change your findings.

If you are presenting at the ILS22 lectern, you can press the Down button in this ILS22Setup wizard until the motor stops and the lectern can't go any lower. Based on the measured lowest position, you can adjust lowest, highest and rise-time values. Press the Mark lowest button and the following form will come up to allow you to adjust to an initial height.

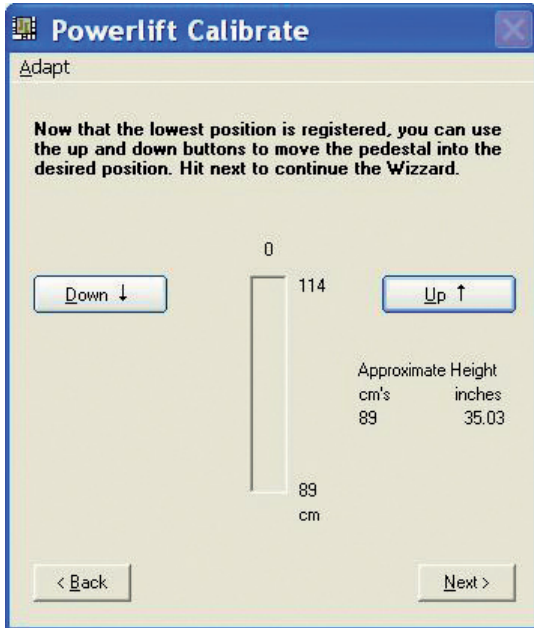

Press the Down or Up buttons to elevate the pedestal into a required default position. The approximate height values will be adjusted accordingly.

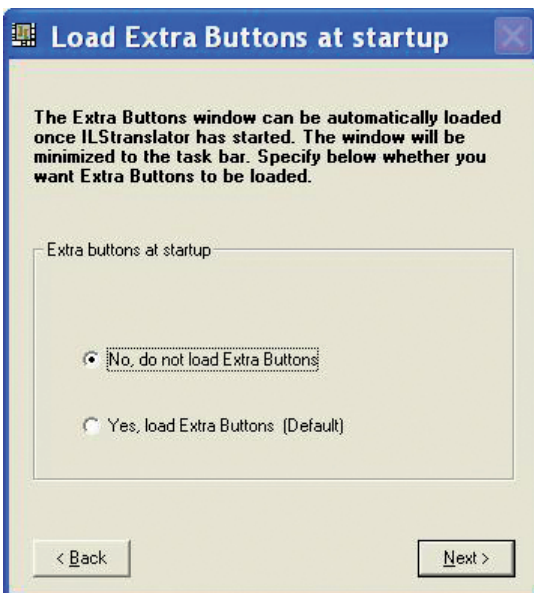

Press the Next button to continue.

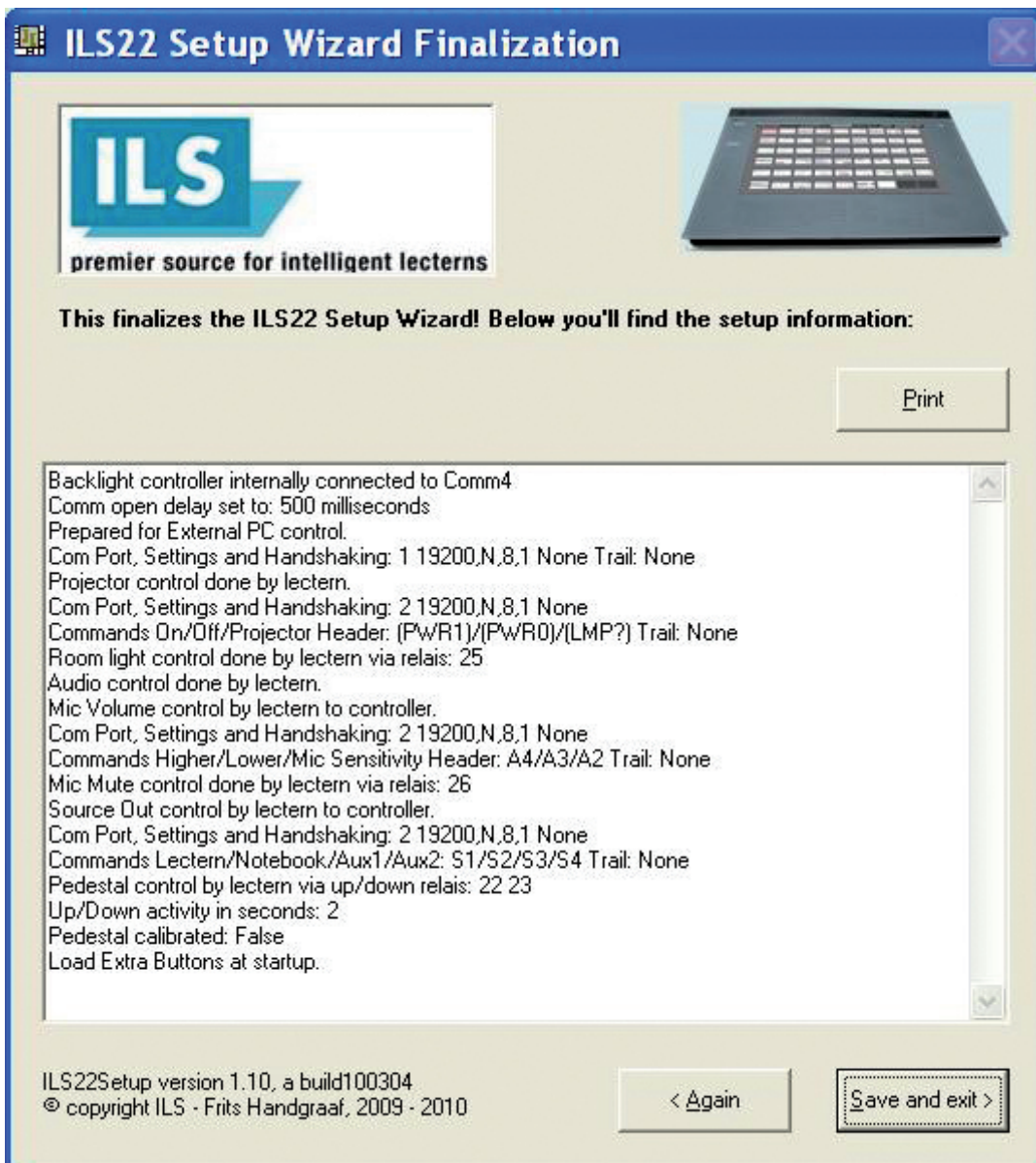

At the end of the wizard, an overview of the settings you entered will be provided.

Press the Save and exit button to save the settings to system registry.

If you would like to adjust the settings Press the Again button to restart the Wizard.

When ILStranlator is started up, it will read the ILS22Setup settings from the registry and act accordingly.

Note: Within ILStranlator, these settings can not be changed. Therefore, restart ILStranlator if changes were made in ILS22Setup, and you want them to take effect.

Note: To configure the ILS according to your preferences, you only need to run the ILS22Setup Wizard once

Appendix, the glass plate function buttons and headers.

